



EUROFENDER

TAKING CARE
ABOUT
THE FUTURE

2023
MUDGUARDS
COLLECTION

EUROFENDER



ALL MODELS
AVAILABLE IN

100%
recycled
plastic

**ON THE
RIGHT
WAY**

TUTTI I MODELLI
DISPONIBILI IN

100%
plastica
riciclata

// MODEL

Tempo square

The Tempo system is a quick and easy system that can be fixed in any desired position. It allows to have the double rod where necessary. The length of the rods is customizable.

Il sistema Tempo è un facile e rapido sistema che può essere fissato in qualsiasi posizione si desidera. Permette di avere la doppia asta ove necessario. La lunghezza delle aste è personalizzabile.

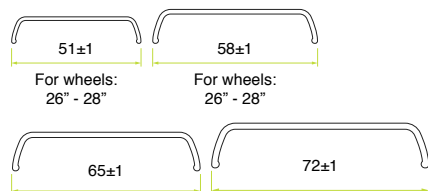

// MODEL

Duo square

The Duo system is suitable for those who want to have the underside of the mudguard free from obstructions. The steel accessories make it very robust. Also this system allows you to have the length of the rods customizable.

Il sistema Duo è indicato per chi desidera avere la parte sotto del parafrangente libera da ingombri. Gli accessori in acciaio lo rendono molto robusto. Anche questo sistema permette di avere la lunghezza delle aste personalizzabile.

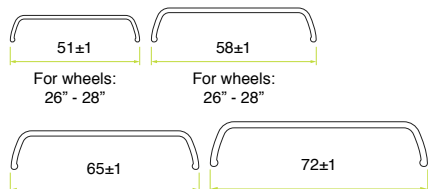



// MODEL

Snello

Snello is a refined system that incorporates the stay hook to the mudflap.

Snello è un raffinato sistema che incorpora l'aggancio dell'asta al paraspruzzo.

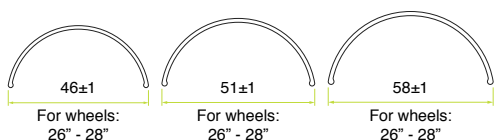

// MODEL

Tempo

The Tempo system is a quick and easy system that can be fixed in any desired position. It allows to have the double rod where necessary. The length of the rods is customizable.

Il sistema Tempo è un facile e rapido sistema che può essere fissato in qualsiasi posizione si desidera. Permette di avere la doppia asta ove necessario. La lunghezza delle aste è personalizzabile.

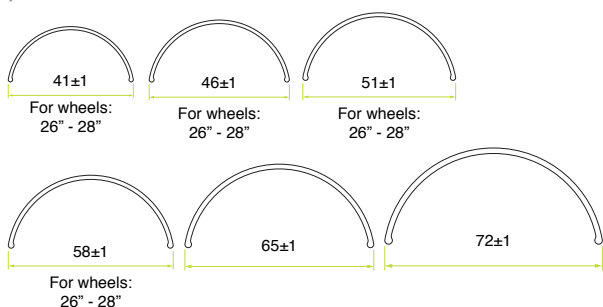

// MODEL

Lampo

The Lampo system comes from the characteristic hook used in the Snello model. This new assembly system is more compact and suitable for wider shapes, especially with the rod above the fender.

Il sistema Lampo è derivato dal caratteristico aggancio utilizzato nel modello Snello. Questo nuovo sistema di assemblaggio è più compatto e adatto alle sagome più larghe, soprattutto con l'asta sopra al parafrangente.

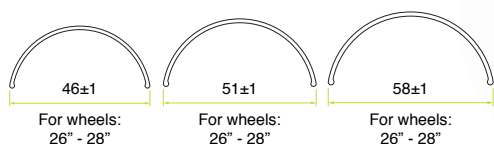

// MODEL

Duo

The Duo system is suitable for those who want to have the underside of the mudguard free from obstructions. The steel accessories make it very robust. Also this system allows you to have the length of the rods customizable.

Il sistema Duo è indicato per chi desidera avere la parte sotto del parafrangente libera da ingombri. Gli accessori in acciaio lo rendono molto robusto. Anche questo sistema permette di avere la lunghezza delle aste personalizzabile.

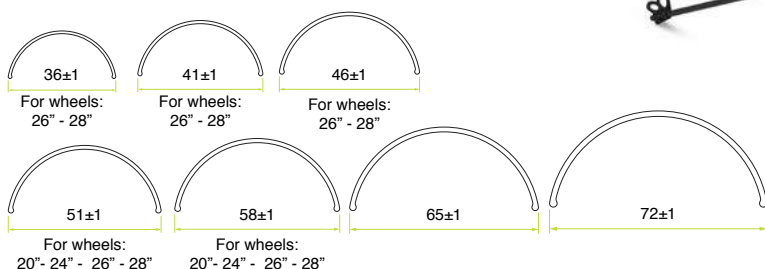



// MODEL

Scatto

With this mounting system, the assembling of the fenders is very easy and fast. The position of the rod external to the fender makes the system suitable for any tyre.

Con questo sistema di assemblaggio il montaggio del parafrango è molto semplice e veloce. La posizione dell'asta esterna al parafrango rende il sistema adatto per qualsiasi battistrada.



// MODEL

Sporty

The Sporty system is practical and strong and specially designed for heavy used quality bikes.

Il sistema Sporty è pratico e robusto e appositamente progettato per bici di qualità usate pesantemente.

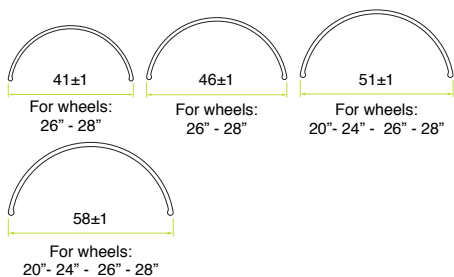

// MODEL

Speedy

NEW

The Speedy system is a new alternative to the Tempo system. The little differences on the design allows it's use without any problem on behalf of Tempo.

Il sistema Speedy è una nuova alternativa al sistema Tempo. Le piccole differenze sul design ne consentono l'utilizzo senza alcun problema da parte di Tempo.

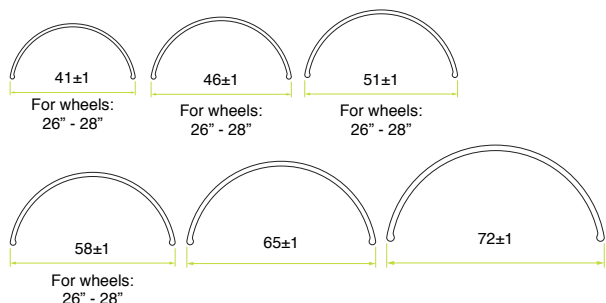

// MODEL

OR-Type

NEW

A durable and easily adjustable system thanks to the fixing screw which guarantees a perfect configuration of the mudguard on the bike.

Un sistema durevole e facilmente regolabile grazie alla vite di fissaggio che garantisce una perfetta configurazione del parafrango sulla bici.

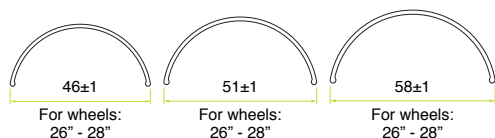



// MODEL

Rapido

A clean system with V-stays. An extraordinary innovation where the fixation hardware is made out of a single piece.

Un sistema pulito con aste a "V". Una straordinaria innovazione in cui il fissaggio è realizzato in un unico pezzo.

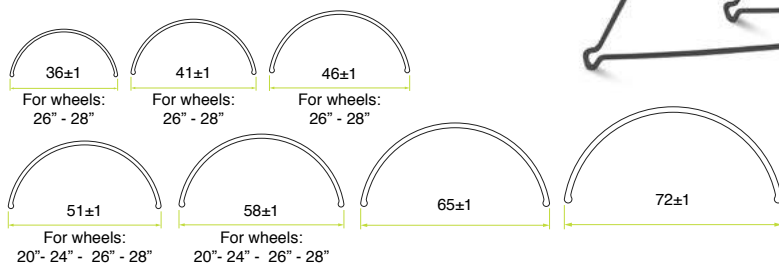

// MODEL

Elegance

Elegant and robust, it's designed for the maximum adjustment possible. Available in stainless steel or galvanized.

Elegante e robusto, è progettato per la massima regolazione possibile. Disponibile in acciaio inossidabile o zincato.

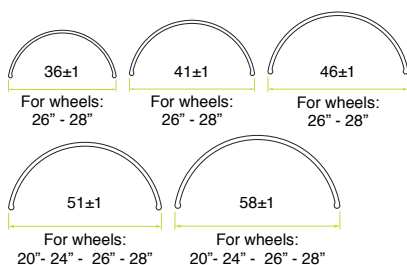

// MODEL

Grip-type

NEW

A system that allows perfect adjustment thanks to the easy locking and unlocking of the rods without any tools.

Un sistema che permette una perfetta regolazione grazie al facile bloccaggio e sbloccaggio delle aste senza alcun attrezzo.

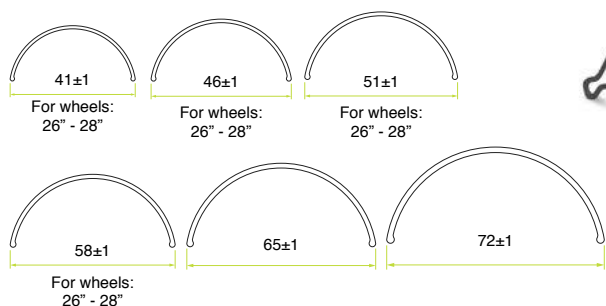

// MODEL

Ecotech

Ecotech is a reliable system that is quick to assemble and gives a stable fixation of the mudguards.

Ecotech è un sistema affidabile, rapido da montare e che garantisce un fissaggio stabile dei parafanghi.

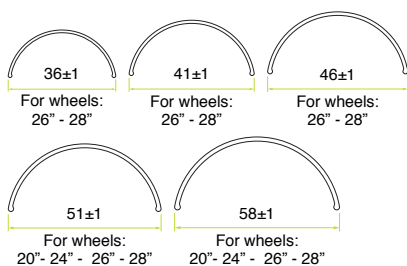

SAFETY RELEASE SYSTEM

Resista

A system designed to improve rider safety. When an object gets caught in the spokes, the Resista system will release the rod from the fork. When you are ready to continue your ride, the rod can be easily reconnected.

Un sistema progettato per migliorare la sicurezza del pilota. Quando un oggetto rimane impigliato nei raggi, il sistema Resista sgancerà l'asta dalla forcella. Quando sei pronto per continuare la tua corsa, il soggiorno può essere facilmente ricollegato.



SAFETY RELEASE SYSTEM

AID System



The AID System is designed to improve rider safety using bicycle with “V” rods. When an object gets caught in the spokes, the safety system will release the rods from the front fork. When you are ready to continue your ride, the rods can be easily reconnected.

Il sistema AID è progettato per migliorare la sicurezza del ciclista utilizzando biciclette con foderi a “V”. Quando un oggetto rimane incastrato tra i raggi, il sistema di sicurezza sgancia i foderi dalla forcella anteriore. Quando sei pronto per continuare la tua corsa, il soggiorno può essere facilmente ricollegato.

// MODEL

Extra wide shapes

Specifically designed for oversized wheels. The Extra Wide mudguards are based on the Duo system and feature the versatile customizable stay length.

Specificamente progettato per ruote di grandi dimensioni. I parafanghi Extra Wide si basano sul sistema Duo e sono caratterizzati da una lunghezza di aste versatile e personalizzabile.

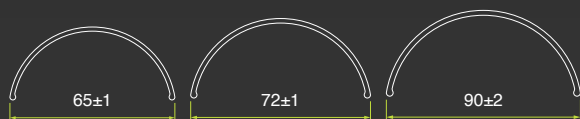

OPTION
Fixing system
from inside

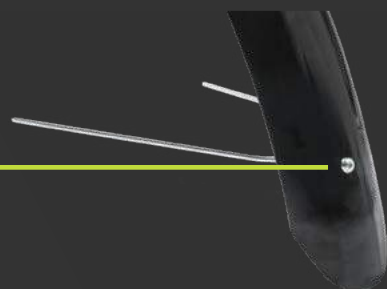

OPZIONE
Sistema di fissaggio
da sotto



// PACKAGING NEGOZIO

Aftermarket packaging

INCLUDED IN THE PACK // INCLUSO NELLA CONFEZIONE

SYSTEM FOR

RAPIDO | SPORTY | ELEGANCE | GRIP-TYP | OR-TYPE

Are equipped with "V" stays in stainless steel, Front nose, Front and rear mudflaps and Sliding bridge

Sono equipaggiati con aste a "V" in acciaio inox, parapunta, spoiler anteriore e posteriore e supporto scorrevole.

SYSTEM FOR

TEMPO | SNELLO | SCATTO | DUO | SPEEDY | LAMPO

Are equipped with 4mm diameter stays in stainless steel, Front nose, Front and rear mudflaps and Sliding bridge.

Available as a complete set or front or rear mudguard separately.

Sono equipaggiati con aste diametro 4mm in acciaio inox, parapunta, spoiler anteriore e posteriore e supporto scorrevole. Disponibili come set completo o anteriore e posteriore separatamente.

FINISHING AVAILABLE COLORS



// MODELLI CONFEZIONABILI

Packable models



E-BIKE'S ELECTRICAL INSTALLATIONS

// IMPIANTI ELETTRICI PER E-BIKE

// MODEL

Flat tunnel & U tunnel

Systems specifically designed for e-bikes with a lot of attention for cable wiring.

Sistemi appositamente progettati per e-bike con molta attenzione per il cablaggio.

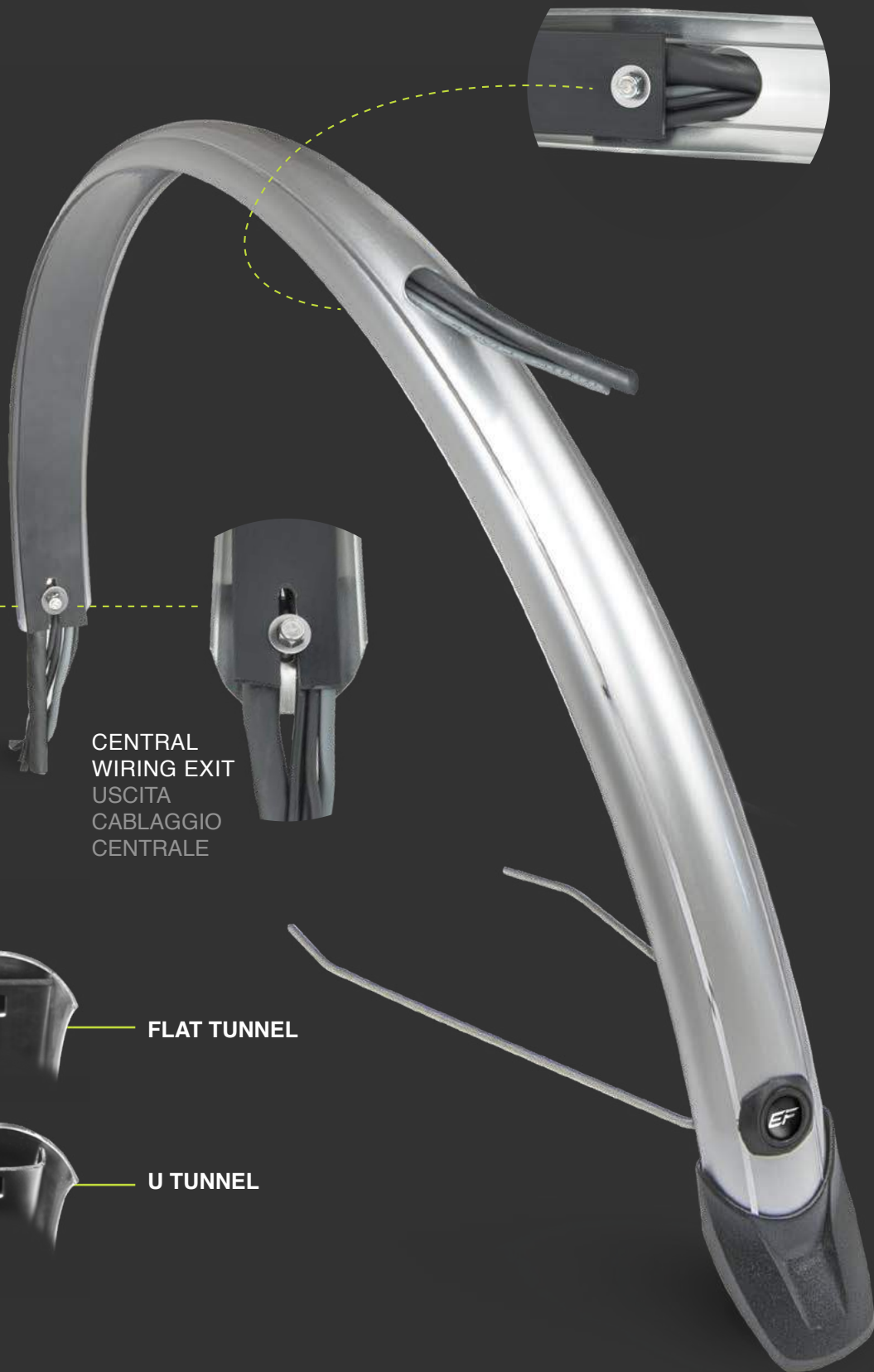

LATERAL
WIRING EXIT
USCITA
CABLAGGIO
LATERALE

CENTRAL
WIRING EXIT
USCITA
CABLAGGIO
CENTRALE

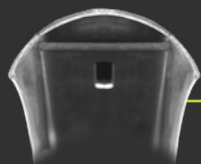

FLAT TUNNEL

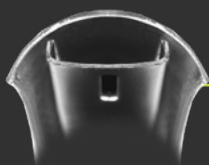

U TUNNEL

// OTHER STANDARD SYSTEMS

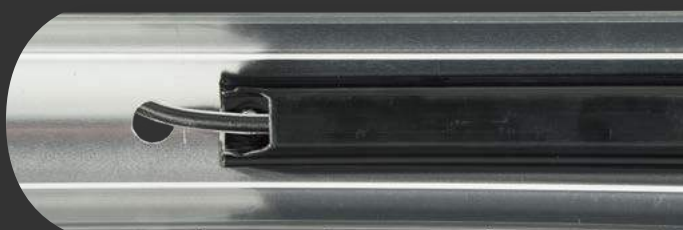

CLOSED TUNNEL / TUNNEL CHIUSO

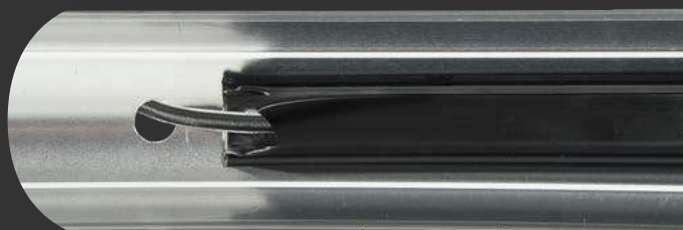

OPEN TUNNEL / TUNNEL APERTO

// FORATURE

drilling

CENTRAL /CENTRALE



LATERAL /LATERALE



R 10mm



R 5mm



10mm



30mm

/CONTATTI ELETTRICI

electrical contacts

SINGLE/SINGOLO



DOUBLE/DOPPIA



OPPOSITE/OPPOSTO



light cable



CENTRAL CONTINUE SYSTEM
SISTEMA CONTINUO CENTRALE



LATERAL CONTINUE SYSTEM
SISTEMA CONTINUO LATERALE



CENTRAL MODULAR SYSTEM
SISTEMA MODULARE CENTRALE



LATERAL MODULAR SYSTEM
SISTEMA MODULARE LATERALE

standard tunnel



CENTRAL POSITION ONLY
SOLAMENTE POSIZIONE CENTRALE

// COLORE ASTE PERSONALIZZABILE

Customizable stay colors



Silver
Argento



Black
Nero



White
Bianco

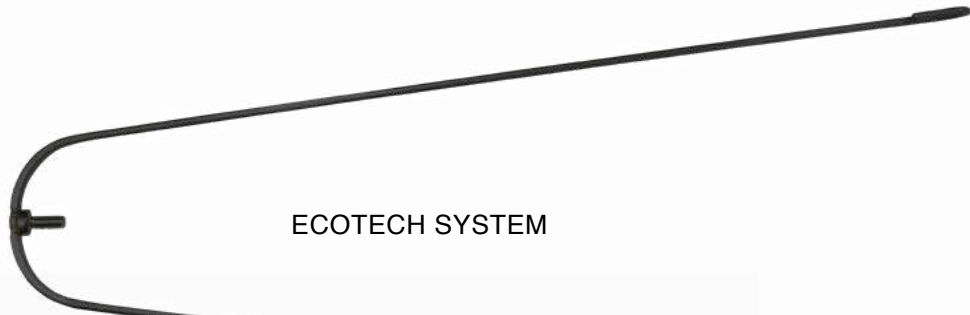

ECOTECH SYSTEM



NORMAL SHAPE



OVERSIZE SHAPE

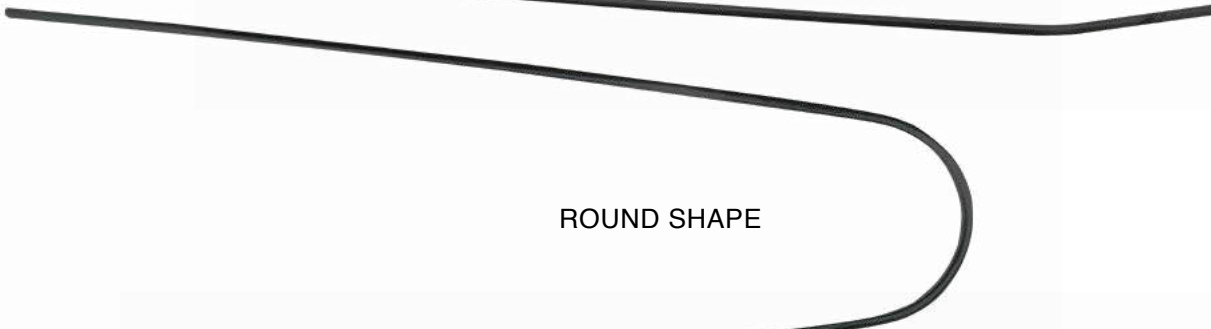

ROUND SHAPE

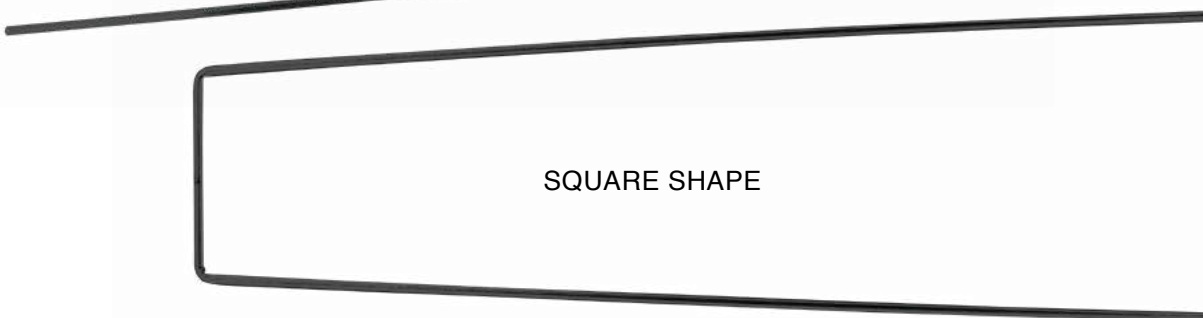

SQUARE SHAPE

// COLORE ASTE STANDARD

Standard stay colors

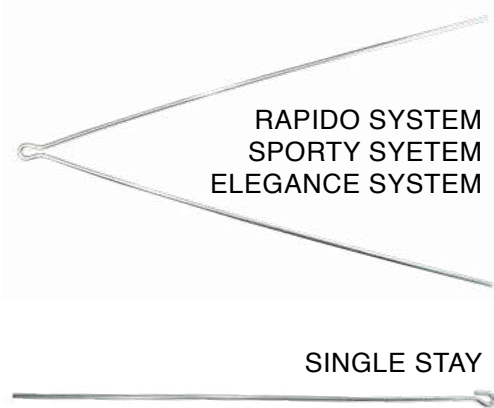

// SISTEMA FINALE ASTE

Stays end systems



// ANGOLARI PER FORCELLA

Suntour fork mount



// SUPPORTO SCORREVOLE

Sliding bridge



// SUPPORTO PORTAPACCHI

Carrier support



// RITAGLIATO

Cut out



// ALETTE

Front square



BELOW FRONT SQUARE
ALETTA PER SOTTO



TOP FRONT SQUARE
ALETTA DA SOPRA



STRAIGHT WAY
ALETTA DRITTA



REVERSE WAY
ALETTA ROVESCIA

// PARAPUNTA

Frontnose



55mm



40mm



27mm



19mm



STANDARD



SQUARE SHAPE

// PARASPRUZZI

Mudflaps



SCATTO

SNELLO

LAMPO

STANDARD

SNAP

// RIFLETTORI

Reflectors



// CLIP

Clips



PLASTIC CLIP
CLIP IN PLASTICA



INOX CLIP
CLIP IN ACCIAIO INOX

// SYSTEMA

Systema

NEW



// FIXING KNOB

Fixing knob



FIXING KNOBS FOR SNELLO CLOSING SYSTEM
FIXING KNOB PER SISTEMA DI CHIUSURA
SNELLO



CUSTOMIZABLE FIXING KNOBS
FIXING KNOB PERSONALIZZABILI

MORE DETAILS & PICTURES
AVAILABLE AT
www.eurofender.it

EUROFENDER_{SRLU}

Via Fornace Seconda Strada 12 A/B // San Giorgio delle Pertiche
35010 Padova - ITALY // Phone +39 049 9620886
eurofender@eurofender.it

